



 **PINLOCK**

MT4S HELMET
THE NEXT GENERATION HELMET

PRE-RIDE CHECKLIST

01



ENSURE YOUR HELMET IS CHARGED

Please use a 5V 2A charger

02



CHECK YOUR SD CARD IS INSERTED

Forcite recommends class 10 SD cards

03



INSTALL THE FORCITE APP



For further questions, please contact
support@forcite.com.au

CONTENTS

MK1S FEATURES	4
MK1S HELMET	5
HELMET MODULE	6
ACCESS PORT COVERS	7
HELMET ALERTS	8
VISOR REMOVAL	10
VISOR INSTALLATION	11
INTERNAL VISOR REMOVAL	12
INTERNAL VISOR INSTALLATION	13
CONTROLLER	14
HANDLE BAR MOUNT	15
MEDIA CABLE	16
MEDIA ON IPHONE	17
HELMET CARE	18
SAFETY AND CUSTOMER SUPPORT	19
FORCITE POLICY	20
WARNINGS	26

MK1S FEATURES



CAMERA SYSTEM (HD 1080 60FPS)



BLUETOOTH (5.0)



PERIPHERAL LED DISPLAY



NAVIGATION GUIDANCE



AUDIO PROMPTS AND NOTIFICATIONS



PLAY AND CONTROL MUSIC



TAKE AND MANAGE PHONE CALLS

A full version of this guide is available for download along with information on new features at support.forcitechelmets.com

MK1S HELMET

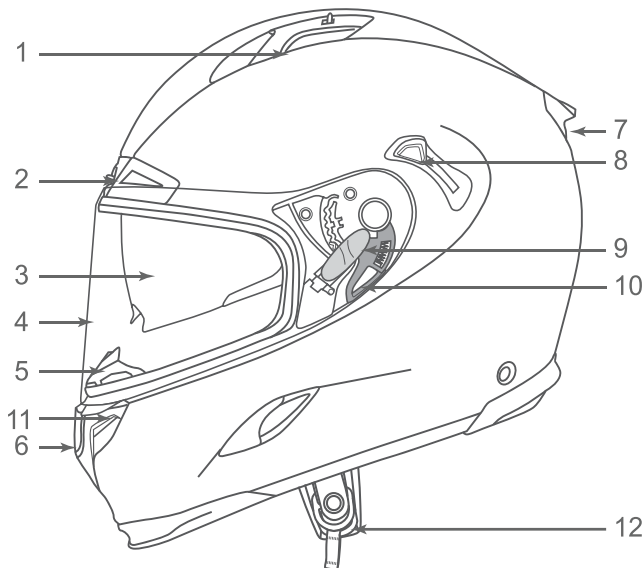

- | | |
|-----------------------|---------------------------|
| 1. Top vent | 7. Rear vent |
| 2. Forehead vent | 8. Sun visor switch |
| 3. Internal sun visor | 9. Visor lock |
| 4. Visor | 10. Visor release trigger |
| 5. Breath deflector | 11. Chin vents |
| 6. Camera | 12. D-loop strap |

HELMET MODULE

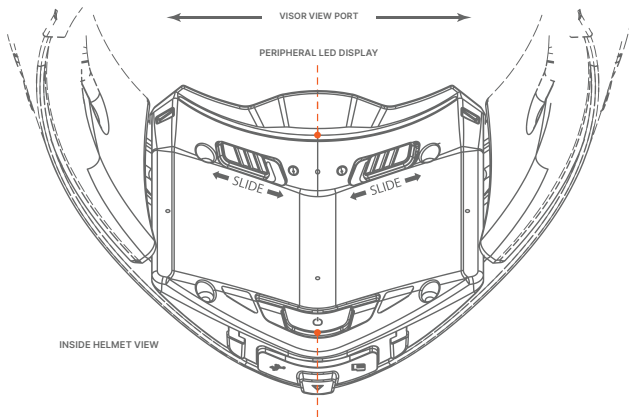

POWER BUTTON

 SINGLE CLICK
POWER ON/OFF

 HOLD 6 SEC
PAIRING MODE

 HOLD 25 SEC
HARD RESET HELMET

SD CARD



CHARGING / DATA

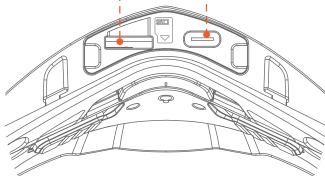

CLOSE UP OF
PORTS UNDER CHIN CURTAIN

ACCESS PORT COVERS

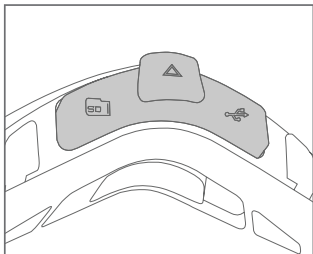
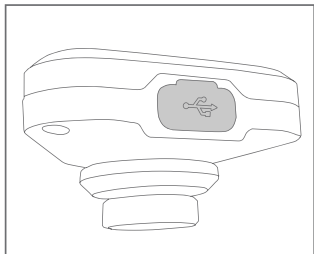

The Forcite helmet and controller each have a rubber access port cover that fits over the charging ports and SD card slot.

CAUTION: Ensure you close these ports firmly to protect the electronics from moisture and dust. If you do not securely close the covers, damage will not be covered by your warranty.

HELMET ALERTS

Road events and navigation instructions are shown on the peripheral display and through audio.

Below is a list of the primary display patterns.

To find a list of all the latest Forcite alerts, please visit support.forcitechelmets.com

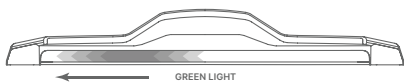

Turn Left

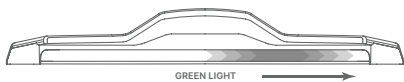

Turn Right

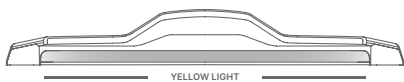

Road Hazard

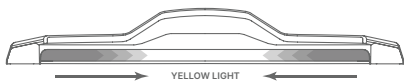

Traffic Jam Ahead

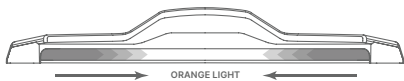

Closure / Accident

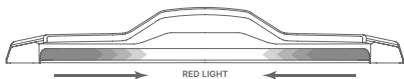

Speed Camera

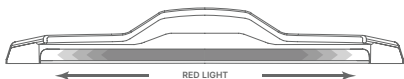

Recording Started

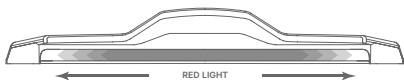

Recording Stopped

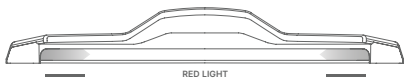

Still recording

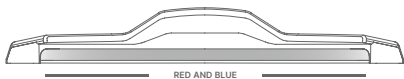

Police Ahead

VISOR REMOVAL

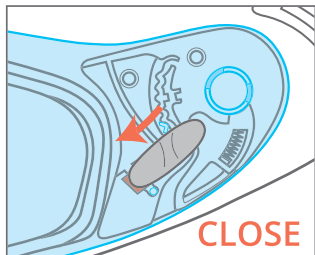
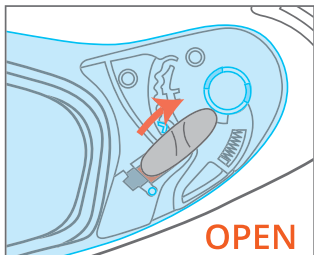

* Before removing the visor, please make sure both sides of the visor lock is in the "OPEN" position.

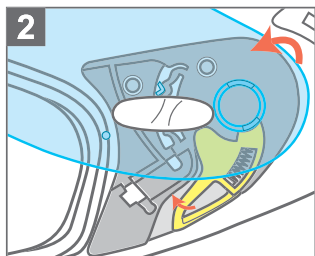
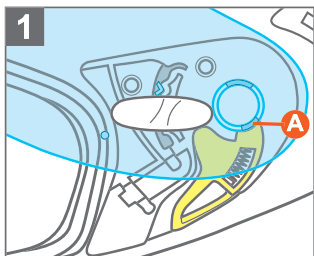

1. Open the visor to the uppermost position, checking that the tab (A) is above the visor release trigger.
2. Pull up the visor release lever and pull the lower edge of the visor out at the same time. Repeat the same procedure on the other side to remove the visor completely.

VISOR INSTALLATION

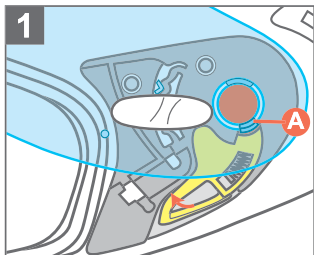

1. Position the visor in its open position over the circular hole on both sides, ensuring the tab (A) is aligned to the visor release trigger

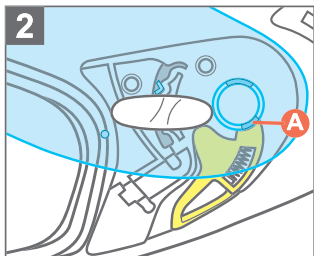

2. Pull the visor release trigger while pushing the visor firmly into place.

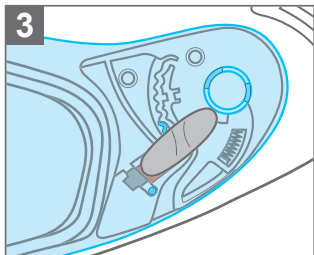

3. Release the visor release trigger.

4. Repeat the same procedure on the other side to complete the installation.

INTERNAL VISOR REMOVAL

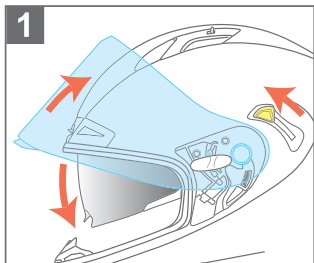

1. Rotate visor to its fully open position. Flip down the internal sun visor using the sun visor switch on the side of the helmet.

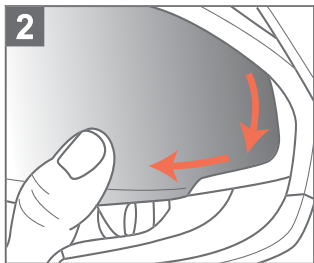

2. Rotate the internal visor down until a small gap is visible, then pull outward firmly to release the sun visor from the mechanism.

INTERNAL VISOR INSTALLATION

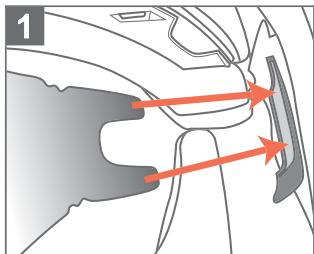

1. Insert the tabs on the sun visor into the mechanism in the direction of the arrow until the internal visor stops. Repeat on the other side and check it's position.

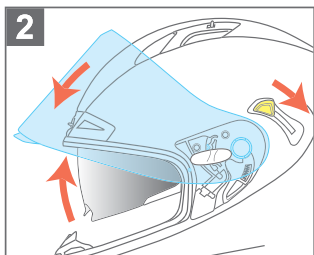

2. Slide the sun visor switch to retract the internal visor back into the shell while checking for smooth movement.

CONTROLLER

NAV BUTTON

- SINGLE CLICK
REPEAT NAVIGATION
INSTRUCTION

■ HOLD 2 SEC
CANCEL NAVIGATION

PHONE BUTTON

- SINGLE PRESS
ANSWER CALL
- ● DOUBLE CLICK
REJECT / HANG UP CALL
- HOLD 2 SEC
SIRI / GOOGLE ASSISTANT

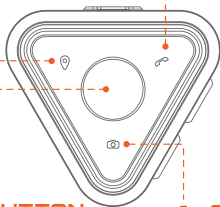

CENTER BUTTON

■ HOLD 2 SEC
ON /OFF

- SINGLE CLICK
PLAY/PAUSE MUSIC

- ● DOUBLE CLICK
SKIP TRACK

- ● ● TRIPLE CLICK
BACK ONE TRACK

■ HOLD 6 SEC
PAIRING MODE

CAMERA BUTTON

- SINGLE CLICK
START/STOP RECORDING

■ HOLD 6 SEC
WIPE SD CARD

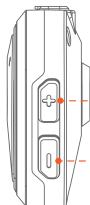

+ VOLUME UP

- VOLUME DOWN

HANDLE BAR MOUNT

The Forcite's handlebar mounting kit comes with two spacers and an additional tightening tool. The mount suits bar sizes $\frac{7}{8}$ " (22mm), 1" (25mm) and 1- $\frac{1}{8}$ " (28mm).

HOW TO MOUNT:

1. Wrap the top and bottom bar mounts around your handle bar and use a spacer to tighten the fit if required.
2. Secure the mounts using the two mount clamp screws provided.
3. Place your controller on top of the top bar mount platform and use the thumb screw to tighten the controller to the handlebar mount.

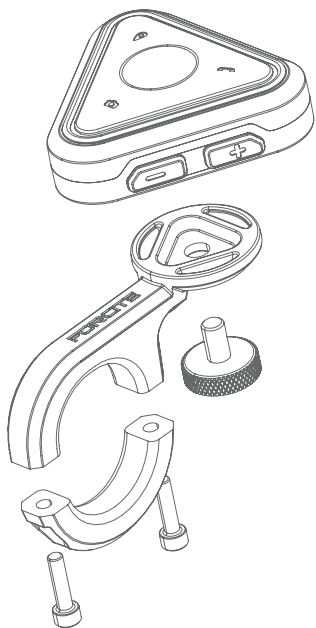

MEDIA CABLE

HOW TO ACCESS MEDIA

The Forcite media manager allows you to view your ride footage, then edit and share it from your phone, by using the media access cable between your phone and helmet.

To access the media manager, go to **Main Menu > Media**

Here you will be prompted to connect your media access cable to your mobile device and Forcite helmet. Ensure the middle USB-C is attached to the helmet, and the other USB-C is connected to your Mobile device.

PHONE USB-C

POWER USB-A

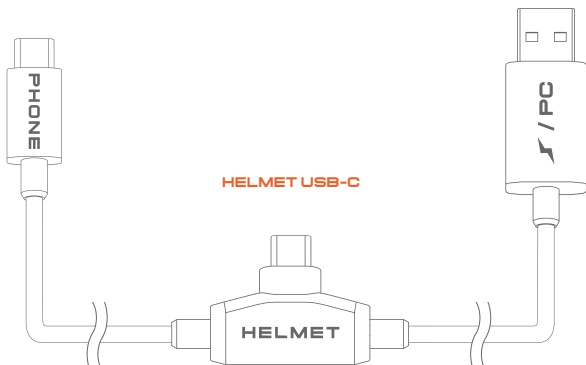

MEDIA ON IPHONE

If you are using an iPhone, you will need to purchase an apple lightning to USB camera adapter which is available in the Apple store. Forcite's media access cable comes with the required USB-A to USB-C adapter.

Once your helmet and phone are connected, follow the instructions in the app to access your media.

**APPLE LIGHTNING
ADAPTER**

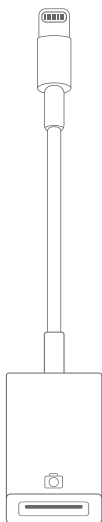

**USB-A TO USB-C
ADAPTER**



HELMET CARE

1. Only use water or mild detergents to clean the visor or the inner liner of the helmet.
2. Remove the visor and the inner liner before cleaning.
3. Gently wash the inner liner by hand with a clean cloth, then let it dry in a ventilated area.

Note: all liners come in different sizes

WARNING

This product can expose you to chemicals which are known to the state of California to cause birth defects or other reproductive harm. For more information, go to <https://www.p65warnings.ca.gov>

IMPORTANT WARNING REGARDING PRODUCT LIMITATIONS

Your new Forcite helmet can protect you in multiple ways when you helmet is correctly fitted and properly fastened to your head. However, no helmet is certain to prevent serious injury or death in an accident, even at speeds less than 20km/hr (13 miles/hr). Always ride with extreme caution, and be sure you have read all instructions to ensure proper helmet use, fit and care.

SAFETY AND CUSTOMER SUPPORT

LED DISPLAY DISCLAIMER

All riders are different, and this product may not be safe for all riders. If the peripheral LED display or any other features are uncomfortable for you to ride with, or any features are too distracting, we recommend you do not use this product to ensure your safety on the road.

The peripheral LED display in the helmet, the audio alerts and sound can be disabled in the main menu of the Forcite app. Only ride with your Forcite helmet if you are comfortable with it's features.

SIZING SWAPS

If you experience any issues with the size or fit of your Forcite helmet, visit forcitehelmets.com/size-swap, or contact our support team directly with any enquiries at support@forcite.com.au.



Pull down on red tags located on the bottom of the cheek pads in case of any emergency, accident or injury

FORCITE POLICY

Thank you for visiting our website or application (our Platform). Our Platform is owned and operated by Forcite Helmet Systems Pty Ltd (ABN 79 165 647 183). By accessing and/or using our Platform or related services, you agree to these Terms and Conditions (Terms), and you also acknowledge that you have read and agree to our Privacy Policy (available at www.forcitechelmets.com). You should review our Privacy Policy and these Terms carefully and immediately cease using our Platform if you do not agree to these Terms. In these Terms, 'us', 'we' and 'our' means Forcite Helmet Systems Pty Ltd (ABN 79 165 647 183) and our related bodies corporate.

Registration and purchasing

You may register as a member to make orders of our products through the Platform and to access certain features of our Platform. When you register and activate your account(or purchase our products), you will provide us with personal information such as your name and email address. You must ensure that this information is accurate and current. We will handle all personal information we collect in accordance with our Privacy Policy. When you register and activate your account, we will provide you with a user name and password. You are responsible for keeping this user name and password secure and are responsible for all use and activity carried out under this user name. If you wish to remain anonymous, for example when writing reviews, we recommend that you use a user name that is not your full legal name. If you are under the age of 16 years, you must not create an account, register as a member or purchase our products. If you are 16 or older but under the age of 18, you represent that you have reviewed these Terms with your parent or legal guardian to make sure that you and your parent or legal guardian understand these Terms. If you are a parent or guardian permitting a person under the age of 18 (a Minor) to create an account, you agree to: exercise supervision over the Minor's use of their account and our Platform; assume all risks associated with the Minor's use of their account and our Platform, including the transmission of content or information to and from third parties via the Internet; ensure that the content and information that the Minor may encounter on our Platform are suitable for the Minor; assume any liabilities resulting from the Minor's use of our Platform and their account, or otherwise in connection with these Terms or use of our products; ensure the accuracy and truthfulness of all information submitted by the Minor; and provide the consents contained in these Terms on behalf of the Minor. We may ask you to confirm that you have your parent's or guardian's permission and that they have agreed to these Terms on your behalf, and, even if we do not do this, we will assume that this is the case and will provide access to our Platform and your account on this basis.

Collection notice

We collect personal information about you in order to provide you with use of our Platform, to supply you with our products and for purposes otherwise set out in our Privacy Policy.

We may disclose that information to third parties that help us deliver our services(including information technology suppliers, communication suppliers and our business partners) or as required by law.

If you do not provide this information, we may not be able to provide all of our products or services to you or be able to provide you with access to our Platform. Our Privacy Policy explains: (i) how we store and use, and how you may access and correct your personal information; (ii) how you can lodge a complaint regarding the handling of your personal information; and (iii) how we will handle any such complaint. If you would like any further information about our privacy policies or practices you can get in touch with us at info@forcite.com.au.

Your consent

By providing your personal information to us, you consent to the collection, use, storage and disclosure of that information as described in our Privacy Policy and these Terms.

Accuracy, completeness and timeliness of information

While we use all reasonable attempts to ensure the accuracy and completeness of the information on our Platform, to the extent permitted by law, including the Australian Consumer Law, we make no warranty regarding the information on our Platform. You should monitor any changes to the information contained on our Platform. We are not liable to you or anyone else if interference with or damage to your computer systems or mobile device occurs in connection with the use of our Platform or a linked website. You must take your own precautions to ensure that whatever you select for your use from our Platform is free of viruses or anything else (such as worms or Trojan horses) that may interfere with or damage the operations of your computer systems or mobile device. We may, from time to time and without notice, change or add to our Platform (including the Terms) or the information, products or services described on it. However, we do not undertake to keep our Platform updated. We are not liable to you or anyone else if errors occur in the information on our Platform or if that information is not up-to-date.

Promotions and competitions

For certain campaigns, promotions or contests, additional terms and conditions may apply. If you want to participate in such a campaign, promotion or contest, you need to agree to the relevant terms and conditions applicable to that campaign, promotion or contest. In case of any inconsistency between such terms and conditions and these Terms, those terms and conditions will prevail.

Purchases Order process

Products displayed on our Platform do not constitute an offer to sell. It is an invitation to treat only. Orders placed by you are offers to purchase particular products under the Terms at the price specified (including delivery and other charges). To the extent permitted by law, we reserve the right to accept or reject your offer for any reason (or no reason) including, but not limited to, the unavailability of any product, an error in the price or product description, or an error in your order. You must review your order carefully before placing it. Once an order is confirmed, you are unable to cancel it. If you have any problems with your order please contact us via info@forcite.com.au. In the event that we cancel or are unable to fulfil your order (including because a product has become unavailable or we cease selling the product for any reason whatsoever), we will provide a full refund of any payment received. Except as required by law (including the Australian Consumer Law), we will not be liable to you for any resulting loss such as you purchasing the product from another retailer at a higher price (including delivery and other charges).

Price, payment and use of discount/coupon codes

The prices of products, delivery and other charges shown are in Australian dollars and include GST where applicable. Prices are current at the time of display but are subject to change. All payments must be received in full prior to dispatch. If your payment is not received or is declined by your bank or credit card issuer, we cannot and will not hold the product against your order. In such instances we do not guarantee that the product will be available should you try to order it again. A discount /coupon code may only be redeemed once per household for an order. These codes may not be used in conjunction with any other discounts. Only one discount/coupon code may be used per order.

Title and risk

Title and risk in the products you order, such as loss or damage, passes to you upon delivery.

Supply and delivery of products

Subject to these Terms, we will supply the products shown on your order confirmation. We will use our best endeavours to meet stated timeframes for delivery, however, many factors(some of which are beyond our control) can affect these timeframes and we cannot guarantee that they will always be met. If you wish to arrange personal pickup of the products please contact us via info@forcite.com.au or 0460310779 to arrange a personal pickup.

Products out of stock

We reserve the right to notify you that products for which you placed orders have become unavailable. In the event that you order a product from our Platform and we later inform you that we no longer stock the product you had originally ordered, we will(at your election) provide you with a store credit or refund to the value of the product that was not supplied to you(including the delivery fee). Store credits may only be used to order from us and are not redeemable for cash. Store credits must be used within 12 months of issue.

Change of mind returns

Please order carefully as we do not offer refunds or exchanges because you have changed your mind after 30 days or you have made an error in finalising your order(such as choosing an incorrect size, colour, model or style). Refunds can only be issued within 30 days of the receipt of the purchased goods, after 30 days you are not eligible for a refund. Size swaps must take place within 30 days of the receipt of the goods, outside of the 30 days you will incur a re-stocking fee. Size swaps can only be done if the helmet is in NEW condition, we cannot size swap used helmets. All products come with 12 months warranty as standard covering all manufacturer faults but not general wear and tear.

Your statutory guarantees

The Australian Consumer Law which forms part of the Competition and Consumer Act 2010(Cth) (Australian Consumer Law) provides certain statutory guarantees which cannot be excluded, restricted or modified. These are in addition to any voluntary warranties offered by the manufacturer or supplier.

Nothing in these Terms affects your rights under the Australian Consumer Law or similar legislation regarding statutory guarantees.

Process for refunds and questions about your product

If you have any questions about your product, please contact us via info@forcite.com.au. Refunds will be issued using the payment method used for purchase. Subject to clause 6.7 - (Your statutory guarantees) (and without limiting clause 11.1(d)), we will not refund a purchase or replace a product where in our reasonable opinion the product has, following delivery to you, become of unacceptable quality due to misuse, failure to use in accordance with manufacturer's instructions, abnormal use or a failure to take reasonable care.

Linked sites

Our Platform may contain links to websites operated by third parties. Those links are provided for convenience and may not remain current or be maintained. Unless expressly stated otherwise, we do not endorse and are not responsible for the content on those linked websites and have no control over or rights in those linked websites.

Intellectual property rights

Unless otherwise indicated, we own or license from third parties all rights, titles and interests (including copyright, designs, patents, trademarks and other intellectual property rights) in our Platform and in all of the material (including all text, graphics, logos, audio and software) made available on our Platform (Content). Your use of our Platform and use of and access to any Content does not grant or transfer any rights, title or interest to you in relation to our Platform or the Content. However, we do grant you a licence to access our Platform and view the Content on these Terms and, where applicable, as expressly authorised by us and/or our third-party licensors. Any reproduction or redistribution of our Platform or the Content is prohibited and may result in civil and criminal penalties. In addition, copying the Content to any other server, location or support for publication, reproduction or distribution is expressly prohibited. All other use, copying or reproduction of our Platform, the Content or any part of it is prohibited, except to the extent permitted by law. If you correspond or communicate with us, or otherwise upload publicly visible content on the Platform, you automatically grant to us an irrevocable, perpetual, non-exclusive, royalty-free, worldwide licence to use, copy, display and distribute such content and to prepare derivative works of the content or incorporate the content into other works in order to publish and promote such content. This may include, but is not limited to, publishing testimonials on our Platform and developing your ideas and suggestions for improved products or services we provide.

No commercial use

Our Platform is for your personal, non-commercial use only. You may not modify, copy, distribute, transmit, display, perform, reproduce, publish, license, commercially exploit, create derivative works from, transfer, or sell any Content, software, products or services contained within our Platform. You may not use our Platform, or any of its Content, to further any commercial purpose, including any advertising or advertising revenue generation activity on your own website.

Unacceptable activity

You must always use our products in a safe manner, and ride vigilantly and according to road conditions and in accordance with traffic laws. You must not submit any content, including traffic or location updates, to our Platform or use our products while operating any vehicle. You must only submit content to our Platform or use our products after you have stopped your vehicle in an appropriate location as permitted by law. You must not do any act that we would deem to be inappropriate, is unlawful or is prohibited by any laws applicable to our Platform or products, including but not limited to: any act that would constitute a breach of either the privacy (including uploading private or personal information without an individual's consent) or any other of the legal rights of individuals or of us; using our Platform to defame or libel us, our employees or other individuals; uploading files that contain viruses that may cause damage to our property or the property of other individuals; or posting or transmitting to this Platform any non - authorised material including, but not limited to, material that is, in our opinion, likely to cause annoyance, or which is defamatory, racist, obscene, threatening, pornographic or which is detrimental to our systems or a third party's systems or network security. If we allow you to post any information to our Platform, we have the right to take down this information at our sole discretion and without notice. You must not interfere with, duplicate, disassemble, decompile, reverse engineer, modify, create derivative works, or otherwise change any of our products or the Platform.

Warranties and disclaimers

Motorcycling is an intrinsically dangerous activity that may result in injury and/or death. Our products are designed to offer comfort and increased safety, but no product can offer total protection against injury or damage of any kind to people or to property in the event of a collision, impact, fall, loss of control or any other type of accident. All motorcyclists and passengers must acknowledge any potential risks involved in motorcycling and decide whether such risks should be taken or not. If you have epilepsy, vision impairment, chronic headaches, deafness, or any other medical condition or circumstances that could affect your concentration while on the road: DO NOT USE OUR PRODUCTS. It is solely your responsibility to determine if our products are safe to use based on your personal circumstances (including by seeking medical advice if necessary). It is solely your responsibility to determine if you can lawfully use our products (and features thereof, including speaker systems, device interoperability, lights and visual displays, etc.) in your particular jurisdiction and with your particular class or level of a vehicle licence. We expressly disclaim all liability associated with any use by you of our products in a manner that is contrary to applicable laws. Subject to clause 6.7 - (Your statutory guarantees), all our products are provided "as is", without any warranties or representations or guarantees of any kind, either express or implied. We and our directors, officers, shareholders, employees, affiliates, agents, contractors and licensors will not be liable for any direct, incidental, special, punitive or consequential damages arising from the use of our products or for any other claim related in any way to the use of our products. Outside of Australia, some jurisdictions do not allow for the exclusion or limitation of liability for certain types of damages, and so in such jurisdictions, our liability shall be limited to the extent it is permitted by law.

Our platform

To the maximum extent permitted by law, including the Australian Consumer Law, we make no warranties or representations about our Platform or the Content, including but not limited to warranties or representations that they will be complete, accurate or up - to - date, that access will be uninterrupted or error-free or free from viruses, or that this Platform will be secure. We reserve the right to restrict, suspend or terminate without notice your access to our Platform, any Content, or any feature of our Platform at any time without notice and we will not be responsible for any loss, cost, damage or liability that may arise as a result. We expressly disclaim all liability arising from your use of our Platform, the information or materials contained on it, or as a result of the inaccessibility of our Platform or the fact that certain information or materials contained on it are incorrect, incomplete or not up-to-date.

Jurisdiction and governing law

Your use of our Platform and these Terms are governed by the law of New South Wales and you submit to the non-exclusive jurisdiction of the courts exercising jurisdiction in New South Wales.

WARNINGS

FCC Warning:

This device complies with Part 15 of the FCC Rules. Operation is subject to the following two conditions: (1) this device may not cause harmful interference, and (2) this device must accept any interference received, including interference that may cause undesired operation.

The user is cautioned that changes or modifications not expressly approved by the party responsible for compliance could void the user's authority to operate the equipment.

This equipment has been tested and found to comply with the limits for a Class B digital device, pursuant to part 15 of the FCC Rules. These limits are designed to provide reasonable protection against harmful interference in a residential installation. This equipment generates uses and can radiate radio frequency energy and, if not installed and used in accordance with the instructions, may cause harmful interference to radio communications. However, there is no guarantee that interference will not occur in a particular installation. If this equipment does cause harmful interference to radio or television reception, which can be determined by turning the equipment off and on, the user is encouraged to try to correct the interference by one or more of the following measures:

- Reorient or relocate the receiving antenna.
- Increase the separation between the equipment and receiver.
- Connect the equipment into an outlet on a circuit different from that to which the receiver is connected.
- Consult the dealer or an experienced radio/TV technician for help.

IC Warning:

This device contains licence-exempt transmitter(s)/receiver(s) that comply with Innovation, Science and Economic Development Canada's licence-exempt RSS(s). Operation is subject to the following two conditions:

1. This device may not cause interference.
2. This device must accept any interference, including interference that may cause undesired operation of the device.
3. This Transmitter must not be co-located or operating in conjunction with any other antenna or transmitter

This equipment complies with IC RSS-102 radiation exposure limits set forth for an uncontrolled environment.



**THANK YOU, AND
RIDE SAFE**

Learn more about Forcite Helmets at
forcitehelmets.com